

SLOW-AXIS COLLIMATION

SAC Lenses

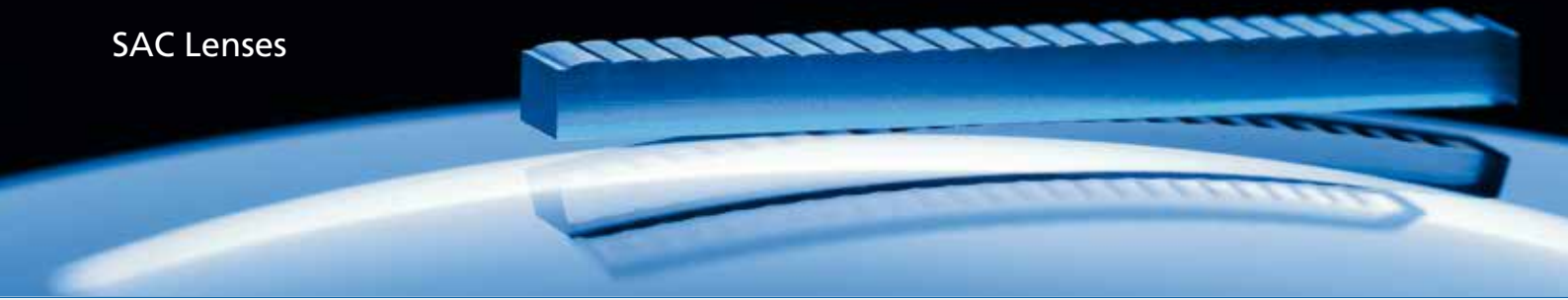

GENERAL DESCRIPTION

The Slow-Axis Collimation optic is a highly efficient means of forming the beam in the slow-axis of diode lasers. It is available either as a monolithic array of cylindrical lenses or as a single lens. All of our optics are produced using high-quality optical glass. The exacting product tolerances guarantee efficient collimation of the light from all emitters and compatibility with laser bars and stacks.

ADVANTAGES

- transmission up to 99%
- minimized dead zones
- highest level of precision and uniformity
- customized solutions with small NRE-costs
- highly economical manufacturing process for large quantities
- reliable and stable quality

PRODUCT SPECTRUM

In order to offer the best solution for your application INGENERIC provides a broad spectrum of Slow-Axis Collimation optics from the shelf. With respect to length and height the lenses can be tailored to your specific needs. For details please refer to the technical specifications on the next side.

SERVICE AND OPTIONS

INGENERIC also designs, develops and manufactures customized SAC lenses, which have been optimized to meet the specific requirements of your application.

- customized numerical aperture, focal length, back focal length and pitch
- customized length and height
- customized coating
- bottom taps, side taps or shoulders for mounting
- single SACs for collimation of single emitters

QUALITY

We operate an extended quality control policy. By testing the lenses with state-of-the-art metrology equipment we ensure superior performance of the SACs within the application at your site. In conjunction with our sophisticated manufacturing technology, this guarantees the production of optics with unsurpassed collimation characteristics.

Slow-Axis Collimation

SAC Lenses

SPECIFICATION DATA

Lens Type	NA	EFL [mm]	PE [mm]	L* [mm]	H** [mm]	CT [mm]
Pitch				200 µm		
SAC-010-200	0.10	1.00	0.20	tbd.	tbd.	1.00
Pitch				400 µm		
SAC-015-400	0.13	1.50	0.40	tbd.	tbd.	1.00
SAC-029-400	0.07	2.90	0.40	tbd.	tbd.	1.00
Pitch				498 µm		
SAC-028-498	0.07	2.80	0.49	tbd.	tbd.	1.00
Pitch				500 µm		
SAC-022-500	0.11	2.20	0.50	tbd.	tbd.	1.00
SAC-026-500	0.09	2.60	0.50	tbd.	tbd.	1.00
SAC-030-500	0.08	3.00	0.50	tbd.	tbd.	1.00
SAC-033-500	0.07	3.30	0.50	tbd.	tbd.	1.00
SAC-035-500	0.07	3.50	0.50	tbd.	tbd.	1.00
SAC-037-500	0.07	3.70	0.50	tbd.	tbd.	1.00
SAC-039-500	0.07	3.70	0.50	tbd.	tbd.	1.00
SAC-040-500	0.06	4.00	0.50	tbd.	tbd.	1.00
SAC-042-500	0.06	4.20	0.50	tbd.	tbd.	1.00
SAC-045-500	0.05	4.50	0.50	tbd.	tbd.	1.00
Pitch				710 µm		
SAC-058-710	0.05	5,8	0.71	tbd.	tbd.	1.00
Pitch				1000 µm		
SAC-035-1000	0.14	3.50	1.00	tbd.	tbd.	1.00
SAC-060-1000	0.08	6.19	1.00	tbd.	tbd.	1.00
SAC-069-1000	0.07	6.90	1.00	tbd.	tbd.	1.00
SAC-073-1000	0.07	7.30	1.00	tbd.	tbd.	1.00
SAC-080-1000	0.06	8.25	1.00	tbd.	tbd.	1.00
SAC-100-1000	0.05	10.30	1.00	tbd.	tbd.	1.00

We further offer SACs with an EFL up to 29.00 mm and a PE up to 3500 µm. Please contact our service team to learn more.

Special Solutions / Smile-Compensating SACs

Upon request, pointing-errors of the fast-axis can be compensated with an SAC
Precondition: Smile-profile of the bar has to be known

Lens Type	NA	EFL [mm]	PE [mm]	L [mm]	H [mm]	CT [mm]	compensated smile-error (mrad)
SAC-035-1000-Smile 1	0.14	3.50	1.00	tbd.	tbd.	1.00	1.00

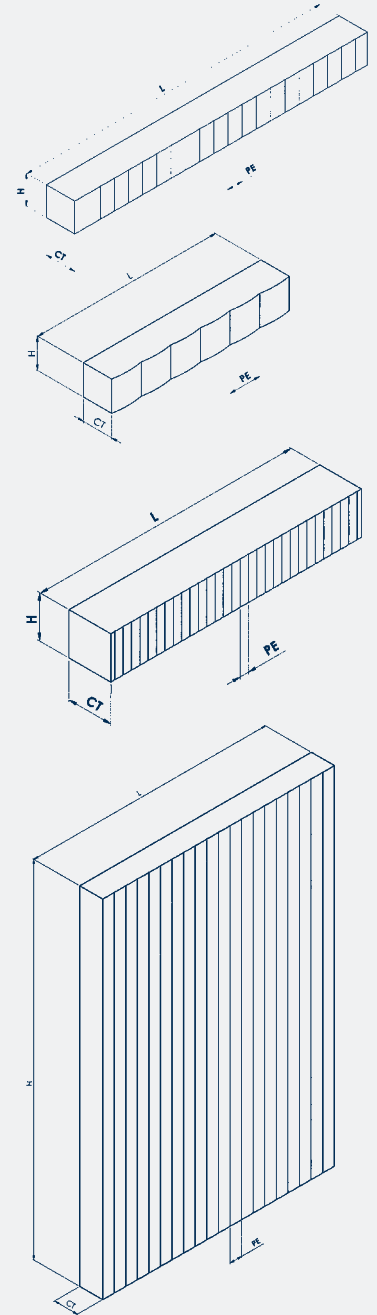

NA: Numerical aperture
EFL: Effective focal length @ 808 nm
BFL: dependent on used FAC
PE: Pitch of emitter
Coating: Standard AR 780-1020 nm

Transmission: > 99%
L*: Length 1.0...14.0mm (+/-0.10 mm) according to customer specification
H**: Height 0.5...15.0 mm (+/- 0.02 mm)
CT: Center Thickness (+/- 0.02 mm)