

Measurement & Spectroscopy

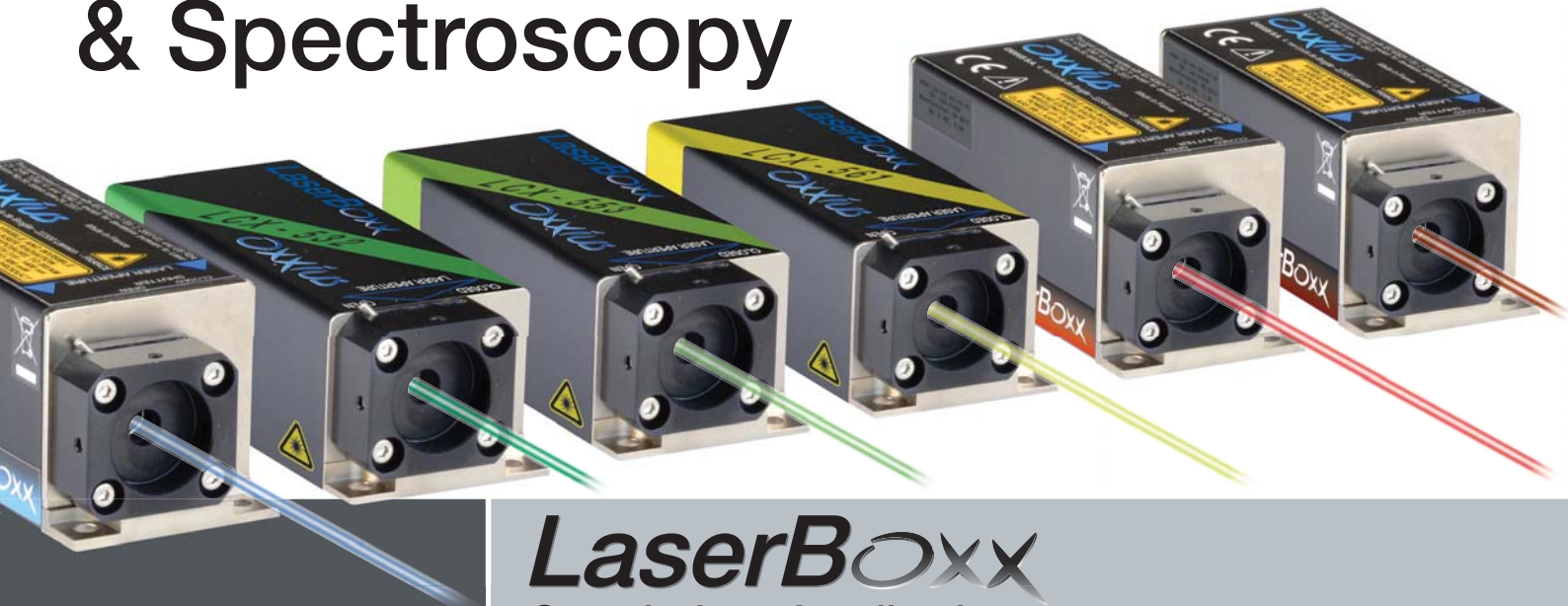

All-in-One laser

- Raman Spectroscopy
- Brillouin Scattering
- Interferometry
- Photoluminescence
- Holography
- Laser Doppler Velocimetry
- Laser Ultrasonic
- Dynamic Light Scattering

LaserBoxx

One platform for all colors

SLM CW Monolithic DPSS benefits

- Up to 500 mW
- Exceptional wavelength stability - 1pm
- Lowest power consumption
 - ▶ ≤ 12 W for LCX's, any wavelength, less than 200 mW
 - ▶ ≤ 15 W for for LCX-532, LCX-1064, 500 mW
 - ▶ ≤ 15 W for for LCX-561, 300 mW
- Low profile laser head (32 mm)
- Tailored beam diameter capability (0.6 up to 1.4 mm)

VBG stabilized Laser Diode modules benefits

- Proprietary SLM locking routine
- Enhanced beam quality versions

Common key features

- Single Longitudinal mode
- TEM₀₀ Beam
- Beam pointing ≤ 5 μm/°C
- SM/PM/MM fiber coupling options
- USB and RS232 computer interface
- Graphic User Interface with remote diagnostics
- Remote *ControlBoxx* with power display (Plug&Play versions - CDRH)
- Controllers integrated into laser head
- Industry standard footprint (100 x 40 mm²)

532	553	561	633	785	830	1064
-----	-----	-----	-----	-----	-----	------

Specifications

	LCX-532S	LCX-553S	LCX-561S	LCX-1064S	LBX-633S	LBX-785S	LBX-830S
Technology	DPSS				Stabilized laser diode		
Optical characteristics							
Emission wavelengths	532.3 nm ± 0.3 nm ⁽¹⁾	553.0 nm ± 0.4 nm	561.4 nm ± 0.4 nm ⁽¹⁾	1064.6 nm ± 0.5 nm	632.5 nm ± 0.5 nm	785 nm	830 nm
Wavelength Stability over 8 hours and ±3°K	≤ 1 pm				≤ 10 pm		
Linewidth	≤ 1 MHz				≤ 100 MHz typ.		
Coherence Length	≥ 100 m				≥ 1 m typ.		
Nominal output power, continuous wave	50 mW to 500 mW	50 mW to 200 mW	50 mW to 300 mW	100 mW to 500 mW	40 mW	100 mW	100 mW
Control mode	Automatic power control (APC)				Locked by embedded software		
Power stability over 8 hours and ±3°K	± 1%						
Power Adjustment Option	30-100%	50-100%	30-100%	30-100%	n/a		
Optical noise % RMS, 10Hz - 20MHz bandwidth	≤ 0.2%						
Transverse singlemode free-space beam (*)							
Beam waist diameter (typ.) at 1/e ² , 50mm from output aperture	0.7 ± 0.1 mm				0.5 to 1.0 mm		
Beam divergence at 1/e ² , full angle, in far field	1.0 ± 0.2 mrad		2.0 ± 0.4 mrad		2 to 4 mrad		
Beam quality factor (M ²)	≤ 1.1				≤ 1.9		
Beam circularity in far field	≥ 90%				≥ 65%		
Beam pointing stability	≤ 5 μrad/°K						
Polarization state	linear, vertical						
Polarization extinction ratio (typ.)	1000:1				100:1		
PM fiber coupling option (*)							
Nominal output power	35 mW to 350 mW	35 mW to 140 mW	35 mW to 210 mW	70 mW to 350 mW	20 mW	40 mW	40 mW

(1) ± 0.5nm at 500mW

(*) Specifications at nominal power

Other available wavelengths: 405 nm, 526 nm, 543 nm, 556 nm

DPSS Monolithic Resonator

Technology

The unique feature of the LaserBoxx DPSS is a proprietary, Alignment-free Monolithic Resonator (AMR). The elements of resonator are assembled into a single ultra-low-loss optical subsystem, using a proprietary crystal bonding technique.

A highly transparent compound, deposited on chemically activated end-faces of two crystals, creates a bond that is extremely robust over time, temperature variations, and insensitive to mechanical vibrations. Dielectric mirrors coated at the end-faces of the crystals complete the monolithic assembly with no moving parts.



Benefits of the AMR

The Oxixus AMR technology offer the highest spectral quality of the market and a high robustness over the time. The LCX lasers are insensitive to temperature variations and mechanical vibrations. High stability and reliability.

LBX-S Platform

Technology

The LBX-S line is a performing driver integrated platform for Volume Bragg Grating stabilized laser diode.

Benefits

The LBX-S delivers ultra narrow linewidth thanks to its excellent temperature stability and low noise current. The Oxixus proprietary embedded firmware locks the laser on same mode at each start up.

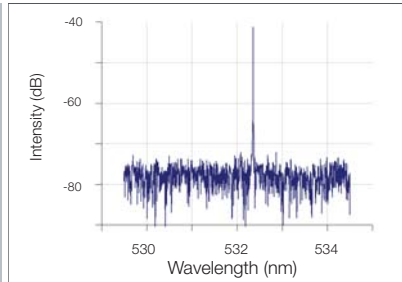

Single Longitudinal Mode
LCX-532S spectrum

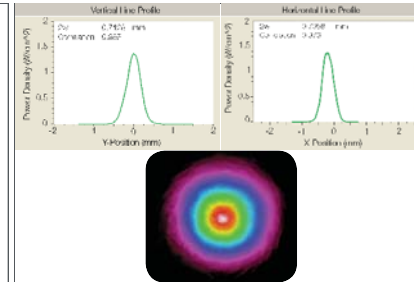

Beam Profile
LCX-553S-200

Wavelength Stability
LCX-561S wavelength vs time

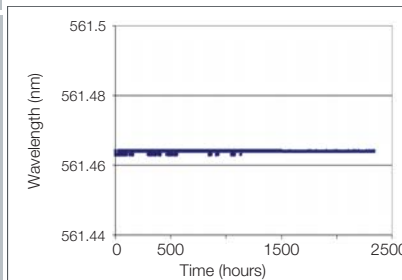

Power Stability
LCX-561S power vs temperature

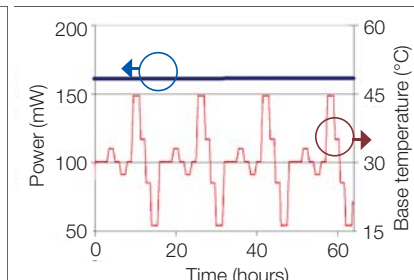

Single Frequency Lasers

System Specifications

Version	LCX-S and LBX-S	LCX-S	LBX-S
	Plug and play	OEM	OEM
CDRH compliance	Yes	No	
Device qualification	CE		
Operating temperature	10 - 38 °C (ambient)	10 - 50 °C (baseplate)	20 - 35 °C (baseplate)
Power Consumption	≤ 25 W	≤ 20 W	≤ 10 W
Storage temperature	0 - 60 °C		
Supply voltage	100 - 240V AC external power supply	5 - 12V DC	
Warm-up time	≤ 10 minutes (LCX) / ≤ 2 minutes (LBX)		
Communication interfaces	USB, RS-232, dedicated I/O interface		
Laser head dimensions	see drawings	100 x 40 x 32 mm ³	100 x 40 x 40 mm ³
Laser head weight	≤ 600 g including heatsink	≤ 250 g	≤ 330 g
Electronic	integrated into laser head		

Controller Plug&Play

Controller (LCX-S) with Power adjustment	ControlBoxx	optional
Controller (LCX-S, LBX-S) fixed power	RemoteBoxx	

Custom Capabilities

- o Wavelength tunability up to 10 pm
- o Tighter wavelength selection
- o Custom wavelengths (526, 556 nm)
- o Opto-mechanical Subassemblies including:
 - Wavelengths combiner (L2C, L4C, L6C)
 - AO modulator (see L2C datasheet)
 - Specific beam diameter or beam shaping
- o Custom control interface
- o Extended operational temperature range

Isolator Output option



The Isolator Output option offers an efficient, compact and cost effective optical feedback protection to LCX or LBX-S lasers. The isolation is ≥ 25 dB and the transmission is $\geq 85\%$. The output polarization is vertical.

The isolator is shipped aligned and mounted with the laser.

Electro-Mechanical shutter option

The ACX-SHTE is a compact and affordable electro-mechanical shutter. It is mounted directly on the LCX or LBX in place of the standard manual shutter. The fiber coupling and other options are fully compatible with the electro-mechanical shutter. The ACX-SHTE is actuated via the LCX embedded software or via a standard TTL signal.

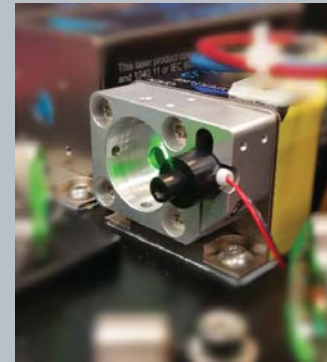

Fiber coupling options

Fiber coupling options offer rugged and compact solutions to couple LaserBoxx into polarization fiber maintaining, standard monomode fiber or multimode fiber.

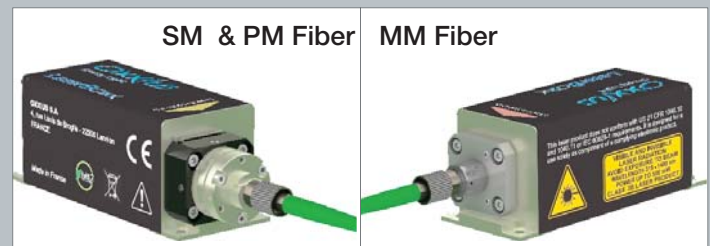

Specifications

SM and PM Fiber	MM Fiber (50 μ m, 0.22 NA)	
$\geq 70\%$	Coupling Efficiency (LCX only)	$\geq 80\%$
100:1	Polarization Ratio (PMF only)	n/a
FC-APC FC/PC, FCP8 on demand	Fiber Output Connector	SMA
$\pm 2\%$	Power Stability over 8 hours, $\pm 1.5\%$ °C	$\pm 2\%$
2 m	Fiber length	2 m

Single Longitudinal Mode LBX-785S spectrum

Si Raman Spectrum obtained with LBX-785S

Beam Profile LBX-633S

LiNb Raman Spectrum obtained with LBX-785S

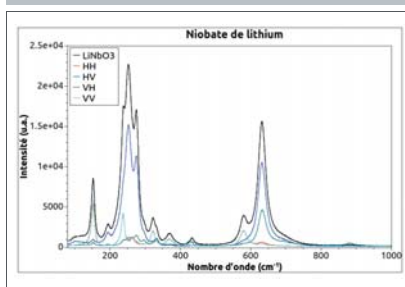
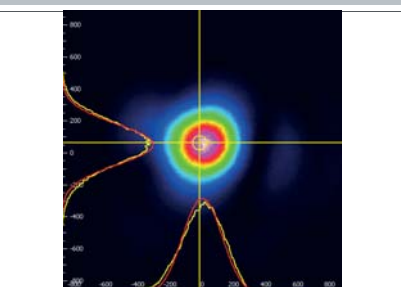
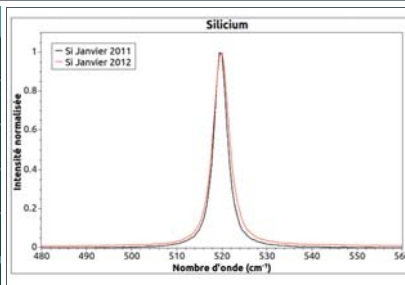
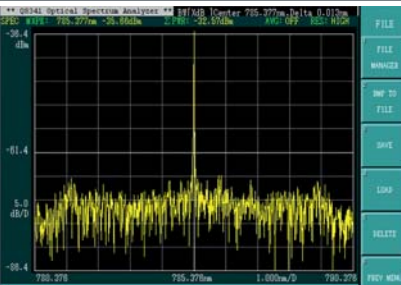

Mechanical Drawings

LCX series, Plug & Play DPSS Laser

CDRH compliant

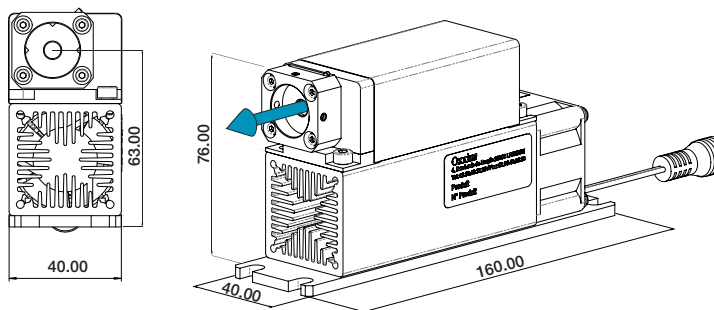

LBX-S series, Plug & Play Laser Diode

CDRH compliant

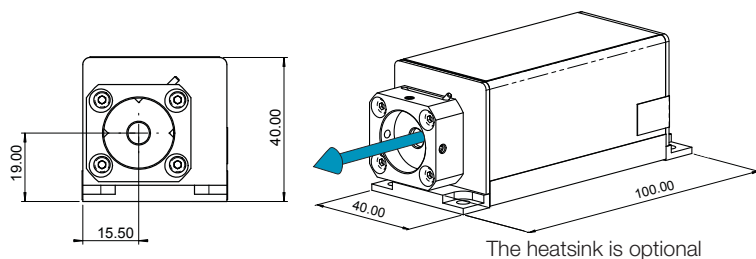

PPA - ControlBoxx

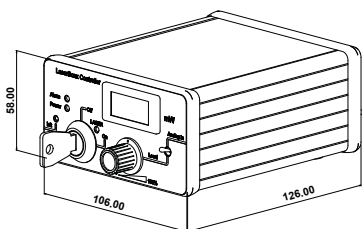

With adjustable power

PPF - RemoteBoxx

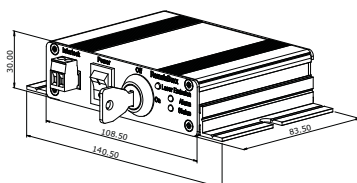

Standard fixed output power

PP - RemoteBoxx

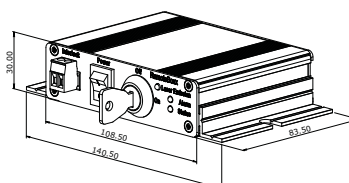

Standard fixed output power

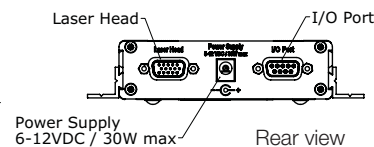

LCX series, OEM DPSS Laser

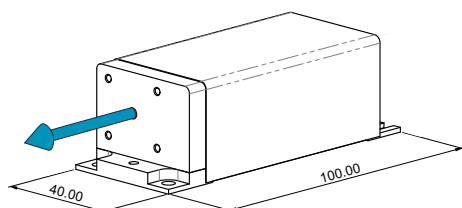
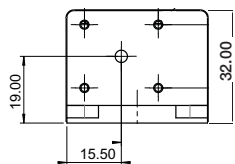

All-In-One laser head with built-in controllers.
Input voltage range: 5-12 V DC

Optional heatsink for LCX series & LBX series

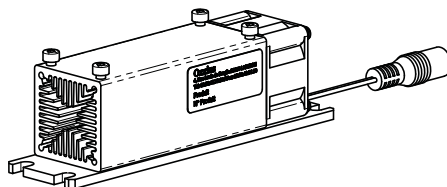
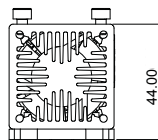

Optional air-forced heat sink for maximum
ambient temperature of 38°C.
Including power supply.

LBX series, OEM Laser Diode

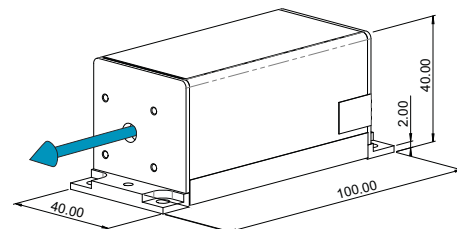
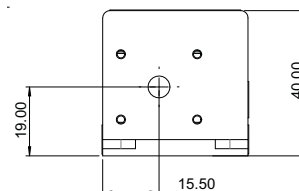

All-In-One laser head with built-in controllers.
Input voltage range: 5-12 V DC

Contact us:

Oxxius S.A.
4 rue Louis de Broglie
F-22300 Lannion, France
Phone: +33 296 48 70 28
Fax: +33 296 48 21 90
sales@oxxius.com
www.oxxius.com



VISIBLE AND INVISIBLE LASER
RADIATION
AVOID EXPOSURE TO BEAM
CLASS 3B LASER PRODUCT
Power up to 500 mW

VISIBLE AND INVISIBLE LASER
RADIATION
AVOID EYE OR SKIN EXPOSURE TO
DIRECT OR SCATTERED RADIATION
CLASS 4 LASER PRODUCT