

NANO**BASE**

Confocal Raman Spectroscopy
Imaging/Analysis Instruments



Three Solid Reasons Why Customers Choose Our Raman System

01 High-Performance Hardware Meets Easy-to-Use Software

Nanobase, Inc. is a renowned manufacturer of high-end Raman spectroscopy imaging instruments with its own manufacturing and developing competence. With our super performing spectrometer and the streamlined NanoSpectrum software suite, our space and time saving Raman systems do not only offer multi-functional analysis tools but also a wide variety of flexibility that enables extension of our system for further key features. Our Raman system highlights are :

- **Multi-functional system**
Raman, Photoluminescence (PL), Electroluminescence (EL), and Fluorescence Lifetime Imaging (FLIm) realized in one system (XperRF)
- **Highly efficient and flexible spectroscopy system**
Interchangeable and rotatable volume phase holographic (VPH) grating
- **Fast, large areal 2-dimensional scanning**
200 μm x 200 μm without sample movement when using a 40X, NA : 0.75 objective
- **Confocal Raman imaging function**
Improved detailed Raman images enable 3-dimensional Raman analysis

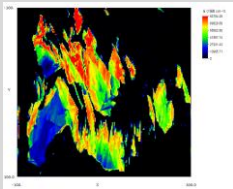

A galvo mirror system and an FHD camera equipped in our **scanning module** offer large area scanning and bright field imaging availability.

An upright **microscope** provides a basic platform for micro Raman spectroscopy. (An inverted microscope option available upon request)

Up to three CW lasers may be set up in our **laser box**. More lasers may be used via fiber ports.

Our Raman filters are designed interchangeable in a **filter box** for corresponding lasers.



We offer different **main platforms** for each instrument type to maximize performance.

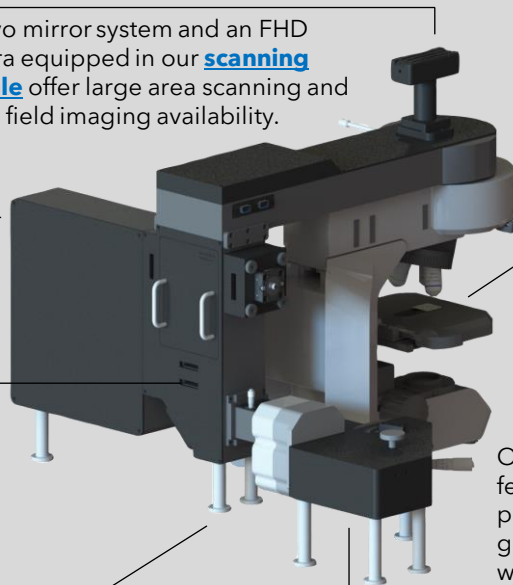

Our **spectrometer** features volume phase holographic grating system which is interchangeable and rotatable to enable various and elaborate experiments.



02 Numerous Raman Options to Take Based on Your Budget

We offer four different Raman spectroscopy instruments, and all the instruments ensure that researchers enjoy our breakthrough spectrometer for customer proven Raman analysis capabilities within any budget range.

XperRF

Our high-end confocal Raman spectroscopy imaging system with a FLLm feature

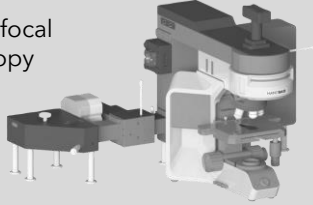

XperRAM S Series

Standard model of our confocal Raman spectroscopy imaging system

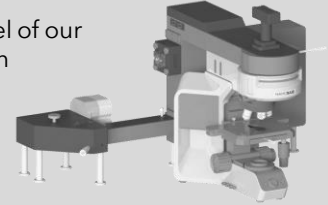

XperRAM C Series

Economical Raman system that offers one laser/filter option

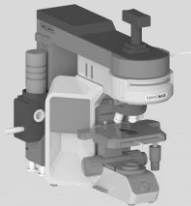

XperRAM M Series

Macro Raman system featuring our high performing spectrometer

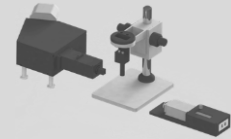

03 System Expandability & Customization : The Sky is the Limit

We simply make our customers' Raman dreams come true! Nanobase, Inc. is one of the very few manufacturers worldwide that offer bespoke Raman products that are tailored to meet each customer's complicated needs. The below four customization projects are just a fraction of over 100 examples that prove our technical creativity and capability.



Raman spectroscopy system combined with a photocurrent measurement system

For Samsung Advanced Institute of Technology

XperRAM S Series was modified for studies on the electrical and optical properties of wire bonded materials such as Si wafer in one system. A supercontinuum laser source was used for this project.



Raman spectroscopy system coupled with a CVD chamber

For Korea Institute of Industrial Technology

This carefully modified XperRAM C Series is for real-time monitoring of CVD process. We also developed an impeccably sealed long-length probe for protection of exposure of chemicals for this project.

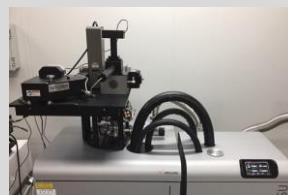

Raman spectroscopy system coupled with a cryostat

For Sungkyunkwan University

XperRAM S Series was modified to be coupled with a cryostat, also with a superconducting magnet system attached. The coupled cryogen-free cryostat provides extremely low temperature environment of 4K.



Raman spectroscopy system for outdoor measurement that comes with a portable case

For National Research Institute of Cultural Heritage

Our Raman system was redesigned for outdoor Raman spectrum measurement. Three VIS lasers (473 nm, 532 nm, and 633 nm) were used to realize this project. To help acquire a micro Raman spectrum, we provided a specially designed microscope station.

XperRF

Catalog No.: XperRF

- Confocal/3D Raman imaging and analysis
- Fast 2D scanning
- Bright field microscopic imaging
- Up to three laser/filter selections
- Interchangeable and rotatable volume phase holographic (VPH) grating selections
- Photoluminescence (PL)
- Electroluminescence (EL)
- Fluorescence lifetime imaging (FLIm)

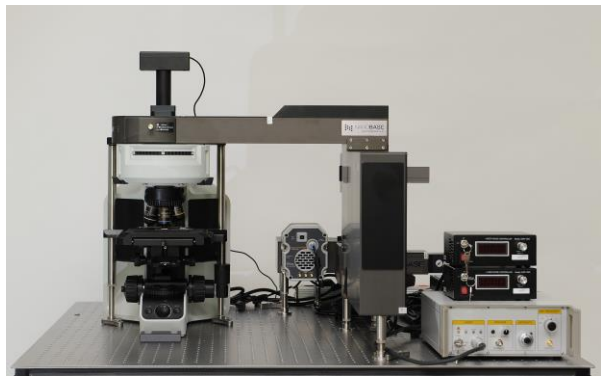

Microscope

- Reflected LED illuminator for bright field
- Mechanical X-Y stage with right-hand control
- Automatically controlled Z-axis position
- Includes main frame, stage plate, control box, interface cable, power cable

Objective

40X

- Magnification: 40X
- Numerical aperture: 0.75
- Working distance: 0.63 mm
- >60% transmission from 360 nm to 1000 nm

Other objective options

- 10X, 20X, 50X, 100X
- Long WD 40X (recommended for photocurrent)

Laser Scanning Module

- Wavelength range: 400~1000 nm
- Laser scanning mode: Raster scan
- Scanning area: 200 μm \times 200 μm (when using a 40X objective lens)

- Includes a 15 MP camera for optical image acquisition (FOV: 220 μm \times 150 μm when using 40X)
- A controller is included (USB1.1)

Laser

Up to three lasers may be chosen for XperRF

- 532 nm Freespace
- 532 nm Freespace for low frequency measurement

- 405 nm Freespace
- 633 nm Freespace
- 785 nm Freespace
- 1064 nm Freespace

Optical Filter

Choose filters corresponding to laser wavelength

- 532 nm Raman PL filter
- 532 nm Raman filter for low frequency measurement

- 405 nm Raman PL filter
- 633 nm Raman PL filter
- 785 nm Raman PL filter
- 1064 nm Raman PL filter

System Platform

- 1 slot to connect a laser neutral density (ND) filter or a polarizer
- 2 slots to connect polarizers or waveplates
- 1 slot to connect an interchangeable Raman-PL filter set

- Up to 3 DPSS lasers are installable
- Provides a robust platform for stable beam alignment

Spectrometer

XPE 200 Monochromator

- Input aperture ratio: f/5
- Focal length: 200 mm
- Spectral range: Max. 5940 cm^{-1}
- Spectral resolution (FWHM): Min. 2.5 cm^{-1}

Detector

- Back-illuminated CCD
- Active pixels: 2000 \times 256 pxls (Pixel size: 15 \times 15 μm)
- Dark current: As low as 0.033 e⁻/pixel/sec
- Quantum efficiency: >40% from 400 nm to 1000 nm

Grating

Choose as many as needed

- 300 lpmm at 900 nm
- 600 lpmm at 600 nm
- 1200 lpmm at 840 nm

- 1800 lpmm at 532 nm
- 2400 lpmm at 450 nm

NanoSpectrum Software Suite

- Raman/PL spectrum acquisition & imaging
- Spectrum data export format: .txt, .csv
- 2D mapping data export format: .spm, .csv
- Option: TRPL spectrum acquisition & imaging
- Option: Photocurrent acquisition & imaging

TCSPC Package

- RF platform (switch box)
- Single Photon Avalanche Detector
- Time tagging electronics

- 405 nm Picosecond pulsed diode laser and driver (other lasers available upon request)

XperRAM S Series

Catalog No.: XperRAM-S

- Confocal/3D Raman imaging and analysis
- Fast 2D scanning
- Bright field microscopic imaging
- Up to three laser/filter selections
- Interchangeable and rotatable VPH grating selections
- Photoluminescence (PL)
- Electroluminescence (EL)

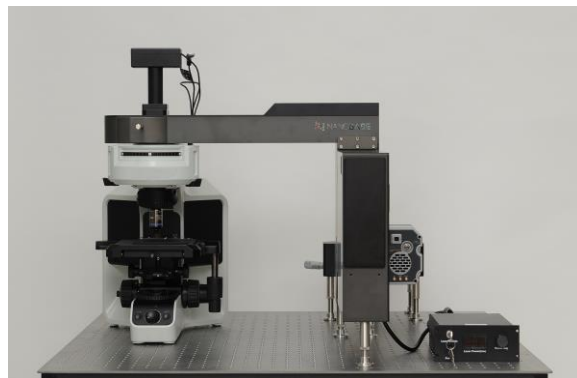

- Reflected LED illuminator for bright field
- Mechanical X-Y stage with right-hand control
- Automatically controlled Z-axis position
- Includes main frame, stage plate, control box, interface cable, power cable

40X

- Magnification: 40X
- Numerical aperture: 0.75
- Working distance: 0.63 mm
- >60% transmission from 360 nm to 1000 nm

- Wavelength range: 400~1000 nm
- Laser scanning mode: Raster scan
- Scanning area: 200 μm \times 200 μm (when using a 40X objective lens)

Other objective options

- 10X, 20X, 50X, 100X
- Long WD 40X (recommended for photocurrent)

- Includes a 15 MP camera for optical image acquisition (FOV: 220 μm \times 150 μm when using 40X)
- A controller is included (USB1.1)

Up to three lasers may be chosen for XperRAM S Series

- 532 nm Freespace
- 532 nm Freespace for low frequency measurement
- 405 nm Freespace
- 633 nm Freespace
- 785 nm Freespace
- 1064 nm Freespace

Choose filters corresponding to laser wavelength

- 532 nm Raman PL filter
- 532 nm Raman filter for low frequency measurement
- 405 nm Raman PL filter
- 633 nm Raman PL filter
- 785 nm Raman PL filter
- 1064 nm Raman PL filter

- 1 slot to connect a laser neutral density (ND) filter or a polarizer
- 2 slots to connect a polarizers or waveplates
- 1 slot to connect an interchangeable Raman-PL filter set
- Up to 3 DPSS lasers are installable
- Provides a robust platform for stable beam alignment

XPE 200 Monochromator

- Input aperture ratio: f/5
- Focal length: 200 mm
- Spectral range: Max. 5940 cm^{-1}
- Spectral resolution (FWHM): Min. 2.5 cm^{-1}

Detector

- Back-illuminated CCD
- Active pixels: 2000 \times 256 pxls (Pixel size: 15 \times 15 μm)
- Dark current: As low as 0.033 e⁻/pixel/sec
- Quantum efficiency: >40% from 400 nm to 1000 nm

Choose as many as needed

- 300 lpmm at 900 nm
- 600 lpmm at 600 nm
- 1200 lpmm at 840 nm
- 1800 lpmm at 532 nm
- 2400 lpmm at 450 nm

- Raman/PL spectrum acquisition & imaging
- Spectrum data export format: .txt, .csv
- 2D mapping data export format: .spm, .csv
- Option: Photocurrent acquisition & imaging

XperRAM C Series

Catalog No.: XperRAM-C

- Confocal/3D Raman imaging and analysis
- Fast 2D scanning
- Bright field microscopic imaging
- Only one laser/filter equipped
- Interchangeable and rotatable VPH grating selections
- Photoluminescence (PL)
- Electroluminescence (EL)



- Reflected LED illuminator for bright field
- Mechanical X-Y stage with right-hand control
- Automatically controlled Z-axis position
- Includes main frame, stage plate, control box, interface cable, power cable

40X

- Magnification: 40X
- Numerical aperture: 0.75
- Working distance: 0.63 mm
- >60% transmission from 360 nm to 1000 nm

- Wavelength range: 400~1000 nm
- Laser scanning mode: Raster scan
- Scanning area: 200 μm \times 200 μm (when using a 40X objective lens)

- 532 nm Freespace

- 532 nm Raman PL filter

- 1 slot to connect a laser neutral density (ND) filter or a polarizer
- 2 slots to connect polarizers or waveplates

XPE 35 Monochromator

- Input aperture ratio : f/5
- Focal length: 35 mm
- Spectral range: Max. 8150 cm^{-1}
- Spectral resolution (FWHM): Min. 3.1 cm^{-1}

Choose as many as needed

- 300 lpmm at 900 nm
- 600 lpmm at 600 nm
- 1200 lpmm at 840 nm

- Raman/PL spectrum acquisition & imaging
- Spectrum data export format: .txt, .csv
- 2D mapping data export format: .spm, .csv
- Option: Photocurrent acquisition & imaging

Other objective options

- 10X, 20X, 50X, 100X
- Long WD 40X (recommended for photocurrent)

- Includes a 15 MP camera for optical image acquisition (FOV: 220 μm \times 150 μm when using 40X)
- A controller is included (USB1.1)

- 1 DPSS laser is installable
- Provides a robust platform for stable beam alignment

Detector

- Active pixels: 1931 \times 1451 pxls (Pixel size: 4.54 \times 4.54 μm)
- Dark current: \sim 0.0002 e⁻/pixel/sec
- Quantum efficiency: >55% from 400 nm to 700 nm

- 1800 lpmm at 532 nm
- 2400 lpmm at 450 nm

XperRAM M Series

Catalog No.: XperRAM-M

- Macro areal Raman analysis
- One laser/probe default setting
- Unlimited number of lasers/probes can be installed (ask for pricing)
- Photoluminescence (PL)

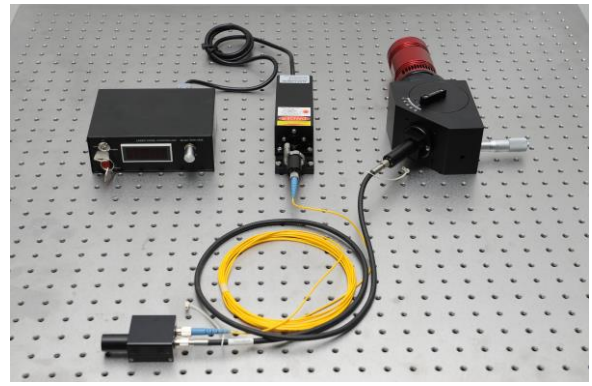

- 785 nm Fiber coupled Raman laser

- 785 nm Raman Probe

XPE 85F

- Input aperture ratio : f/1.4
- Focal length: 85 mm
- Spectral range: Max. 3900 cm^{-1}
- Spectral resolution (FWHM): Min. 2.5 cm^{-1}
- 1200 lpmm at 840 nm (optimal)
(other gratings also available)

Detector

- Back-illuminated CCD
- Active pixels: 2000 \times 256 pxls (Pixel size: 15 \times 15 μm)
- Dark current: As low as 0.033 e⁻/pixel/sec
- Quantum efficiency: >40% from 400 nm to 1000 nm

- Raman/PL spectrum acquisition



NANOBASE

#1406-1, 196 Gasan-digital-1-ro, Geumcheon-gu
Seoul 08502, South Korea

Hotline +82 70 8666 0233

Fax +82 2 852 9013

E-mail nbsales@nanobase.co.kr

Web www.nanobase.co.kr